

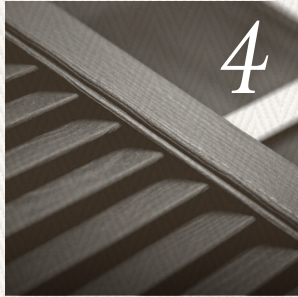

Put the accent on *style*.

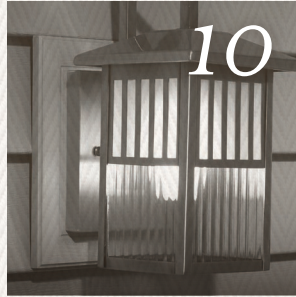

SHUTTERS



MOUNTING
BLOCKS



VENTS



DESIGNER
ACCENTS

Exceed Your Expectations with Ply Gem Shutters and Accents



Because your home is a reflection of you, your exterior finishings should be able to reflect the highest level of quality and widest breadth of styles. And with Ply Gem Shutters and Accents, that's exactly what you'll discover — high-quality, low-maintenance, customizable products that help you express yourself... *beautifully*.



SELECTING & ORDERING

Service

- Simplified buying process that's easy to follow
- Overnight service available

Quality

- Engineered to retain their color through any weather for years
- Durable construction will not crack, split, or fade — guaranteed
- Limited Lifetime Warranty

Selection

- Available in over 100 different colors that complement virtually any building material — including brick, stone, wood, steel, aluminum, fiber cement and vinyl siding
- Wide range of styles to match a multitude of applications
- Optional custom built-to-order shutter program provides tailored sizes to fit your needs

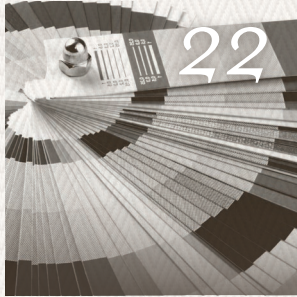

THE COLOR OF BRILLIANCE

Outstanding Service.
Unsurpassed Quality.
Remarkable Selection.
It's time to feel at home *again*.



shutters

Quality Shutters for Any Home

Our high-quality shutters are built to look as good as your home — whether it's brick, stone, vinyl siding, stucco or wood.

Virtually Maintenance-Free

Ply Gem shutters retain their high quality and vibrant color through the life of your home, and are virtually maintenance-free. We achieve this tremendous quality through our use of advanced UV stabilizers and a tough acrylic coating, which minimize the effects of sun, rain and wind.

Industry-Leading Warranty

All of our high-quality shutters are built to last a lifetime. Ply Gem shutters will not split, crack or peel. In fact, we feel so strongly about our quality that we offer a Limited Lifetime Warranty on all of our shutters*.

A Style and Color for You

Our three elegant panel styles create the perfect fit for your home. Ply Gem offers classic styles like the Louvered design, Board & Batten design, as well as the Raised Panel design. Our shutters are available in 19 classic colors, factory finished to ensure quality and consistency. And when styles change they can also be painted with a high-quality latex paint. Ply Gem's durable design allows you to repaint the shutters over again.

Variety of Sizes to Fit your Windows

Ply Gem shutters come in a wide variety of standard heights and widths to fit virtually any window. If one of our many standard sizes will not work, we can custom make virtually any length of shutter in raised panel and louvered styles to meet your needs.



*See warranty for details and limitations.



Your home is your own personal retreat. Wrap it in the beauty and elegance of our shutter collection.

Shutter Styles

Raised Panel Shutters

Raised Panel shutters offer the unique, turn-of-the-century look of the grand homes of the South, but with a contemporary richness and style. Their simple lines create a striking profile to your home that is reminiscent of our early American heritage. Ply Gem's Raised Panel shutters can be purchased in both custom and standard sizes, and come with our Limited Lifetime Warranty. They can be paired with matching transom tops or arch tops for added height and impact.

Louvered Shutters

Nothing gives your home a classic look like Louvered shutters. Steeped in the traditions of American history, our elegant Louvered shutters provide the perfect finishing touch to your home by capturing the rich, natural woodgrain texture of real wood shutters — but without the splitting, cracking and peeling. Ply Gem Louvered shutters can be paired with arched tops to accent circle top windows.

Board & Batten Shutters

Open or closed, 3- or 4-Panel, Board & Batten style shutters add a rustic look to any home and are perfect for a variety of design styles, from Country to Craftsman.



Raised Panel

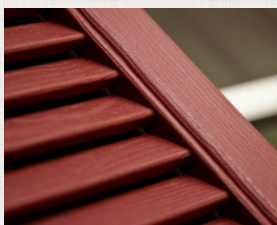

Beautiful Colors

Ply Gem shutters are available in 19 beautiful colors, specially selected by our national color expert.



Elegant Arched Tops

Our arched tops add height and elegance to the shutter's appearance. Available for our 15" Raised Panel and Louvered standard shutters, these extensions give an added look of richness to your home's exterior.



Louvered



Board & Batten
Closed Style



Board & Batten
Open Style



Shutter Accessories

Our decorative hinges and hooks complete the look of traditional working shutters — without the maintenance. Like our shutters, they're fade-resistant and built to last.

Side By Side, Our Shutters Are Superior By Design

Details



Ply Gem's tab-free construction, realistic beaded detail and clean edges mimic the look of real wood shutters. Inferior products often use tabs that when removed leave obviously plastic jagged edges.

Installation

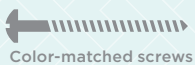

Ply Gem raised panel or louvered shutters offer several installation options: plugs, matching screws or optional hidden fasteners. Both plugs and matching screws are supplied standard with each carton (unlike some of our competitors who provide only plastic plugs). Unique to Ply Gem, our Board & Batten shutters have a hidden installation feature shown above. The batten slides over to hide the screws.

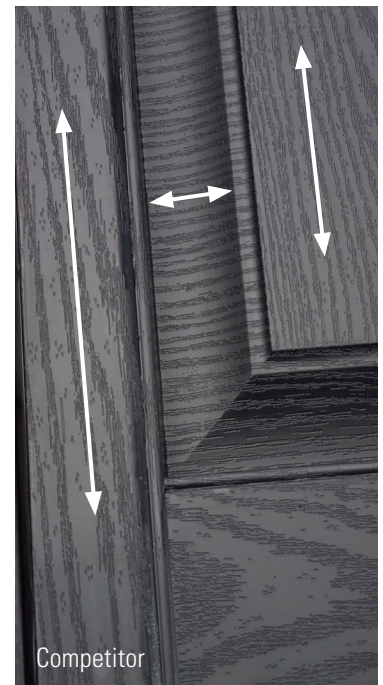
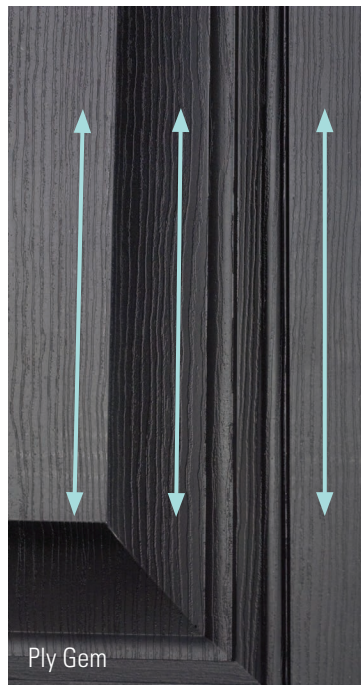

Authentic

Real beauty comes from realistic woodgrain. Ply Gem accurately depicts the grain of real beveled wood panels on every edge and surface. Our competitors' grain runs in multiple directions, and doesn't extend beyond the shutter face.

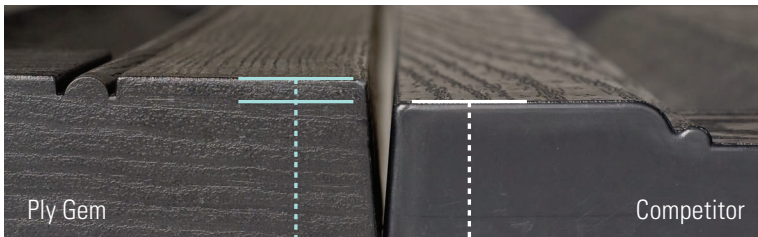
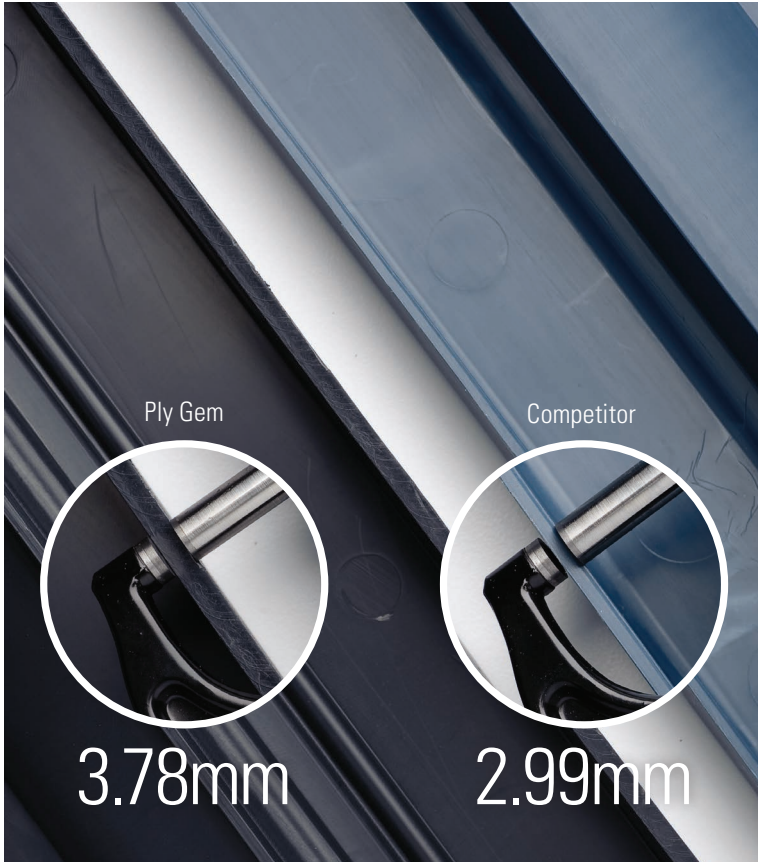

Substantial

Thicker is better. Ply Gem shutters are up to 21% thicker and have up to 1/8" thicker profile than competitor shutters. Our thicker gauge construction adds strength and rigidity for reliable performance and durability. The thicker profile supports greater profile depth that creates realistic shadow lines. Our reinforced construction resists warping and results in a heavier, sturdier shutter. In fact, Ply Gem shutters weigh up to 25% more than the competitor's.



Durable

Scratch ours and you can hardly tell; scratch theirs and you'll see what they're made of. Our baked-on lacquer finish resists fade and retains beauty season after season. Their color-through coating scratches easily and can fade over time. As well as being scratch-resistant, Ply Gem shutters accept latex paint beautifully, so if you want to update your look, you can. Latex paint can peel off competitor's shutters over time.

mounting blocks

Mounting blocks are used to install electrical outlets, water faucets, light fixtures, mailboxes, house numbers, and even doorbells.



Quality Assurance



Our mounting blocks are built to withstand the toughest weather and retain their color and beauty over the life of your home. They will not chip, crack or split. All of our mounting blocks are backed by our Limited Lifetime Warranty.

Simple to Install



Our mounting blocks have a two-piece design that easily adjusts from 1/2" to 1 1/4". This feature allows for easy installation over a variety of siding choices, including insulated vinyl siding.

A Perfect Color Match



Our mounting blocks are available in over 100 beautiful colors and can be matched to virtually any vinyl siding color.

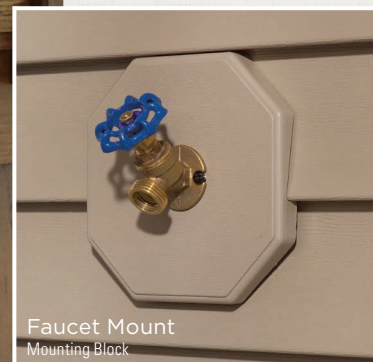

Faucet Mount
Mounting Block

vents

We design vents for a wide variety of uses, with the classic styling and vast color palette that you've come to expect from Ply Gem. All of our vents are specially engineered to prevent intrusion by birds, insects, and animals, and are made to last for years to come.



The Right Colors for You

Any of our vents are available in over 100 beautiful colors. They can be matched to most colors and virtually any siding option. The paintable version can be painted to match any unique color with a high-quality latex paint.

Utility Vents

Our utility vents are sturdy and provide excellent cross-ventilation of garages, foundations, and range hoods. The Louvered Exhaust Vent is ideal for removing the moist air of dryers and bathrooms. Intake louvers and soffit intakes work in tandem with the vents to maximize the flow of air, allowing your family to breathe easier. With Ply Gem utility vents, your home not only looks beautiful, but feels fresher.

Gable Vents

For the perfect finishing touch to your home, our gable vents are offered in round, half-round, square, octagonal, and rectangular styles to fit the look you want to create — whether it's classic or contemporary. Best of all, our uniquely designed snap-on system is easy to install, helping to keep your attic ventilated and temperate.



Snap-On Installation System
Gable Vent



Louvered Exhaust Vent
Utility Vent



designer accents

Our mantel and door surround systems are compatible with nearly any style of home. They are simple to install and virtually maintenance-free over the life of your home.

Mantel Systems

Ply Gem's mantel systems are not only functional, they are beautiful. Mantel systems give your home a stately appearance by adding height and symmetry to the windows and garage doors. Endcaps and keystones add to the grandeur and are available for siding or brick applications. They are available in a classic design or with an optional dentil trim for a richer appearance.

AVAILABLE IN THE FOLLOWING WIDTHS

36" 44"
40" 120"*

*120" ideal for garage doors.

Door Surrounds

Ply Gem's door surround systems welcome your guests with a stately entrance. They can be sized to fit most standard doorways and are built from our special mix of highly-durable polystyrene that withstands wear and tear. Our broad selection of door surround systems includes pilasters and mantel or pediment with urn overlays.

AVAILABLE IN THE FOLLOWING HEIGHTS

96" 144"



Customizable Color

All of our Designer Accents are available in classic white, our most popular color. Ply Gem Window and Door Surround Systems can also be painted to custom match any color with a high-quality latex paint and can be repainted over the years as styles change.



Black
(33)

Gray
(16)

Blackwatch
Green (99)

Dark Spruce
(56)

Green
(55)

Spanish Moss
(93)

Dark Navy
(95)

Color & Style Selection

Choosing the right Ply Gem shutter for your home is easy. First, select the color that complements your home's exterior. Then, choose the style that best suits your personality. Add arch top or transom top extensions for added height and elegance.



Cottage Style



Standard Style
(Raised Panel)



Standard Style
(Louvered)

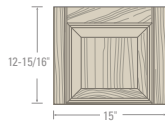

Transom Top
(Raised Panel)

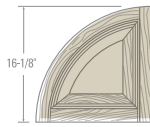

Arch Top
(Raised Panel)

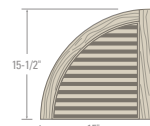

Arch Top
(Louvered)

Board & Batten

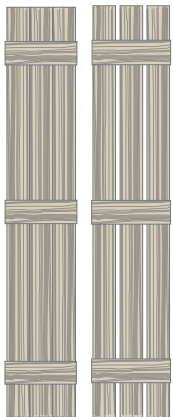

3-Board
Closed



3-Board
Open



4-Board
Closed



4-Board
Open

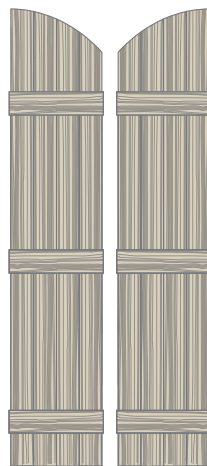

4-Board Closed
Arch Top*

Shutters up to 51" length have two horizontal boards.

Shutters up to 55" length and larger have three horizontal boards.

*Available in 4-Board closed, 57" length only.

Size Selection

Next, determine the size that fits your windows by measuring the Length (A) and Width (B). Use the measuring and ordering guide below to determine the correct shutter size.

Raised Panel or Louvered Arch Tops can be added to circle top windows over 15" standard shutters. The Raised Panel Transom Top can be used over 15" standard shutters to accent a transom window.

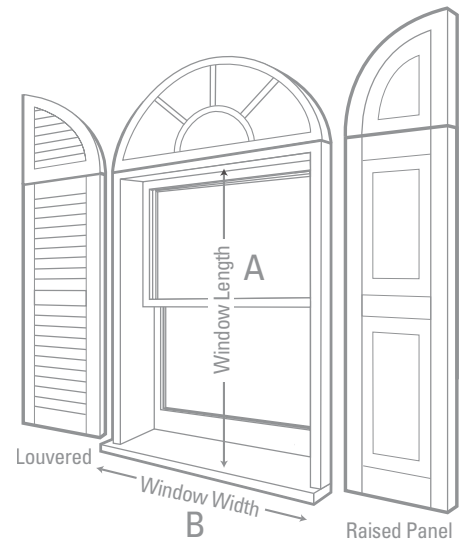

Window Length (A)	Window Width (B)		
	Less than 24"	24" – 26"	More than 26"
25" – 29"	9" x 25**	12" x 27**	15" x 25**
30" – 33"	9" x 31**	11" or 12" x 31"	15" or 16" x 31"
34" – 36"	9" x 35**	11" or 12" x 35"	15" or 16" x 35"
37" – 40"	9" x 39**	11" or 12" x 39"	15" or 16" x 39"
41" – 44"	9" x 43**	11" or 12" x 43"	15" or 16" x 43"
45" – 48"	9" x 47**	11" or 12" x 47"	15" or 16" x 47"
49" – 52"	9" x 51**	11" or 12" x 51"	15" or 16" x 51"
53" – 56"	9" x 55**	11" or 12" x 55"	15" or 16" x 55"
57" – 60"	9" x 59**	11" or 12" x 59"	15" or 16" x 59"
61" – 64"	9" x 63**	11" or 12" x 63"	15" or 16" x 63"
65" – 68"	9" x 67**	11" or 12" x 67"	15" or 16" x 67***
69" – 72"	9" x 71**	11" or 12" x 71"	15" or 16" x 71"
73" – 77"	9" x 75**	—	15" or 16" x 75"
78" – 82"	9" x 81**	—	15" or 16" x 81"
83" – 96"	9" x 83" – 96**	12" x 83" – 96"	15" x 83" – 96"

Ply Gem standard shutters are 11", 12", 15" and 16" wide. 9" Louvered shutters are custom orders. Arch and Transom Tops are available in 15" widths only.

*Available in Louvered style only. **Available in Cottage Style.

■ Indicates Custom Order

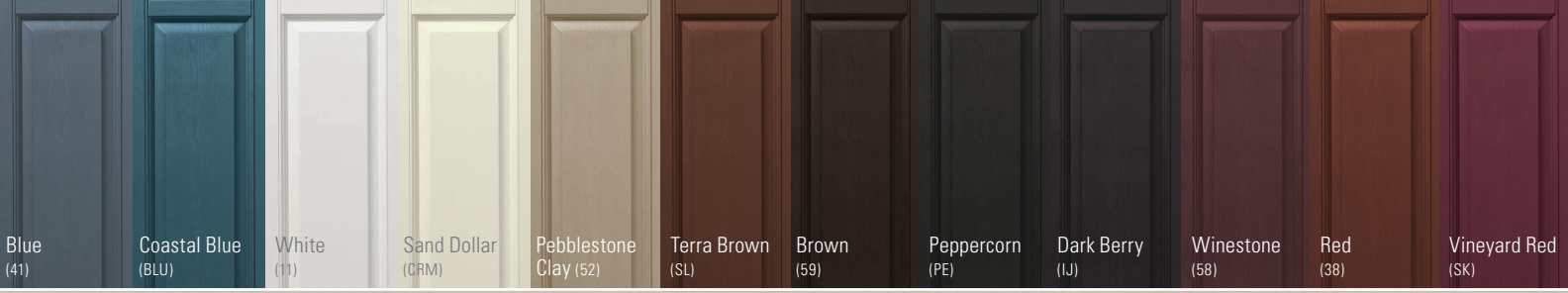

Ordering Guide

Use the guide below to determine what Ply Gem products you need to order. Designate your color selection by adding the three-digit color code to the end of the item number. (e.g., 27" Raised Panel Standard Shutters with 12" width in White would be listed as "VINRP122711").

Window Length	Louvered Standard Shutter Sizes		Raised Panel Standard Shutter Sizes		Board & Batten Shutter Sizes				
	Window Width		Window Width		3-Board Open Style	3-Board Closed Style	4-Board Open Style	4-Board Closed Style	4-Board Closed Style Arch Top
	Nominal 12"	Nominal 15"	Nominal 12"	Nominal 15"	Nominal 12"	Nominal 11"	Nominal 16"	Nominal 15"	Nominal 14"
25"	—	VINLV1525	—	—	—	—	—	—	—
27"	—	—	VINRP1227	—	—	—	—	—	—
31"	—	VINLV1531	VINRP1231	VINRP1531	VIN301231	VIN3C1131	VIN401631	VIN4C1531	—
35"	—	VINLV1535	VINRP1235	VINRP1535	VIN301235	VIN3C1135	VIN401635	VIN4C1535	—
39"	—	VINLV1539	VINRP1239	VINRP1539	VIN301239	VIN3C1139	VIN401639	VIN4C1539	—
41"	—	—	—	—	—	—	—	—	BBARCH41
43"	—	VINLV1543	VINRP1243	VINRP1543	VIN301243	VIN3C1143	VIN401643	VIN4C1543	BBARCH43
47"	—	VINLV1547	VINRP1247	VINRP1547	VIN301247	VIN3C1147	VIN401647	VIN4C1547	—
51"	—	VINLV1551	VINRP1251	VINRP1551	VIN301251	VIN3C1151	VIN401651	VIN4C1551	—
55"	VINLV1255	VINLV1555	VINRP1255	VINRP1555	VIN301255	VIN3C1155	VIN401655	VIN4C1555	—
57"	—	—	—	—	—	—	—	—	BBARCH57
59"	VINLV1259	VINLV1559	VINRP1259	VINRP1559	VIN301259	VIN3C1159	VIN401659	VIN4C1559	—
61"	—	—	—	—	—	—	—	—	BBARCH61
63"	—	VINLV1563	VINRP1263	VINRP1563	VIN301263	VIN3C1163	VIN401663	VIN4C1563	—
65"	—	—	—	—	—	—	—	—	BBARCH65
67"	—	VINLV1567	VINRP1267	VINRP1567	VIN301267	VIN3C1167	VIN401667	VIN4C1567	—
67" Cottage	—	VINLV1567C	—	VINRP1567C	—	—	—	—	—
71"	—	VINLV1571	VINRP1271	VINRP1571	VIN301271	VIN3C1171	VIN401671	VIN4C1571	BBARCH71
73"	—	—	—	—	—	—	—	—	BBARCH73
75"	—	VINLV1575	—	VINRP1575	VIN301275	VIN3C1175	VIN401675	VIN4C1575	—
77"	—	—	—	—	—	—	—	—	BBARCH77
81"	—	VINLV1581	—	VINRP1581	VIN301281	VIN3C1181	VIN401681	VIN4C1581	—
85"	—	—	—	—	—	—	—	—	BBARCH85

Built-to-Order Shutter Program

You can customize our Ply Gem Louvered and Raised Panel shutters for a perfect fit to your home. With the Ply Gem Built-to-Order Program, we can make shutters to perfectly fit your home within 72 hours. Custom sizes are available, in any length from 18" – 96" (in 1" increments). You can even mix and match custom and standard size shutters on the same home. Board & Batten shutters are not available in custom sizes.

Window Width	Louvered Custom Shutter Sizes	Raised Panel Custom Shutter Sizes
	Window Length 18" – 96"	
Nominal 9"	CLV9 + Length	—
Nominal 12"	CLV12 + Length	CRP12 + LENGTH
Nominal 15"	CLV15 + Length	CRP15 + LENGTH

Mounting Blocks



Universal Large
J-Block® Mounting Block
Included Electrical
Box Housing

Universal Large
J-Block® Mounting Block

Universal J-Block®
Square or Scroll-Cut
Square Mounting Block

Universal Jumbo
J-Block® Mounting Block

UL Mounting Block

Uses	The Large J-Block® is designed to mount large light fixtures, house numbers and mailboxes. Works with the UL®-approved Electrical Box Housing, included.	The Large J-Block® is designed to mount large light fixtures, house numbers and mailboxes.	The J-Block® mounts provide multiple uses, including the ability to easily and attractively mount light fixtures and receptacles.	The Jumbo J-Block® is designed to mount oversized light fixtures, house numbers and mailboxes.	The Electrical UL® Mounting Block is designed to mount light fixtures or electrical outlets. Includes electrical box and mounting block.
Product Code	JMEBLØCK	JMBLØCK	Square: UNIBLØCK Scroll-Cut Square: UNIBLØCKSC	UNIBLØCKXL	EBLØCK Includes electrical box and mounting block
Surface Dimensions	8 3/8" x 12 1/2"	8 3/8" x 12 1/2"	7 1/4" x 8 1/8"	9" x 16"	4 7/8" x 5 7/8"
Flange Dimensions	6" x 10 1/8"	6" x 10 1/8"	7 1/4" x 8 1/8"	11.67" x 18.71"	7 1/8" x 8 1/8"
J-Channel I.D.*	1/2" adjusts to 1 1/4"	1/2" adjusts to 1 1/4"	1/2" adjusts to 1 1/4"	1/2" adjusts to 1 1/4"	5/8" adjusts to 1 1/4"
Knockouts	Scored for Rectangular and Round Cut	Scored for Rectangular Cut	Round: 4" Diameter Rectangle: 2 3/8" x 3 3/4"	Round: 3 1/16" Diameter Rectangle: 2 3/16" x 3 3/4"	—
Limited Lifetime WARRANTY	✓	✓	✓	✓	✓
MULTI DEPTH	✓	✓	✓	✓	✓
PERFECT MATCH	✓	✓	✓	✓	✓
Technical Drawings					

* J-Channel internal dimension

Electrical Outlet

Doorbell

Water Faucet

Electric Meter

Oversized Electric Meter

Split Recessed J-Block®
Mounting Block

Mini J-Block®
Mounting Block

E-Z Block™ Surface
Mounting Block

Meter Base
Mounting Block

Large Meter Base
Mounting Block

The Split Recessed J-Block® has a patented hinge that allows for ease of installation without removal of electrical receptacles and water faucets.

The Mini J-Block® mounting block is designed to mount small accessories such as doorbells and electrical outlet receptacles.

The one-piece design can be used after siding installation to mount all types of accessories. Ply Gem offers sizes to fit Double 4", Double 5", Dutch Lap and Triple 3" siding profiles.

The Meter Base Mounting Block is designed to mount large accessories such as hose racks and electric meter bases.

The Large Meter Base Mounting Block accommodates oversized meters.

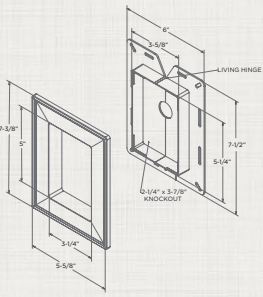
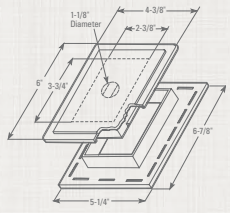
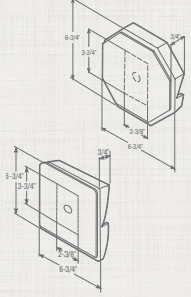
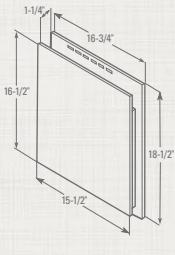
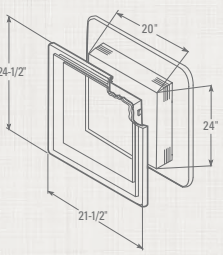
<p>MBLØCKR</p>	<p>MBLØCK</p>	<p>Octagon: EZBLK080 – Double 4" or Double 5" EZBLK110 – Dutch Lap Square: EZBLK070 – Dutch Lap</p>	<p>METER</p>	<p>METERLG</p>
<p>5 5/8" x 7 3/8"</p>	<p>6" x 4 3/8"</p>	<p>6 3/4" x 6 3/4" Projection: 3/4"</p>	<p>16 1/2" x 15 1/2"</p>	<p>20" x 24"</p>
<p>6" x 7 1/2"</p>	<p>6 7/8" x 5 1/4"</p>	<p>—</p>	<p>18 1/2" x 16 3/4"</p>	<p>21 1/2" x 24 1/2"</p>
<p>3/4" adjusts to 1 1/4"</p>	<p>3/4" adjusts to 1 1/4"</p>	<p>—</p>	<p>1 1/4"</p>	<p>1/2" adjusts to 1 1/4"</p>
<p>Rectangle: 2 1/4" x 3 3/8"</p>	<p>Round: 1 1/8" Diameter Rectangle: 2 3/8" x 3 3/4"</p>	<p>Round: 1" Diameter Rectangle: 2 3/8" x 3 3/4"</p>	<p>—</p>	<p>—</p>
<p>✓</p>	<p>✓</p>	<p>✓</p>	<p>✓</p>	<p>✓</p>
<p>✓</p>	<p>✓</p>	<p>✓</p>	<p>✓</p>	<p>✓</p>
<p>✓</p>	<p>✓</p>	<p>✓</p>	<p>✓</p>	<p>✓</p>
				

Utility Vents



	Foundation Vent	Air Vent (Patent #5,293,920)	Louvered Exhaust Vent	Intake Louvered Vent	Soffit Intake Vent	Hooded Exhaust Vent
Uses	The Foundation Vent is used to ventilate crawl space areas. Moveable louvers can be locked open or closed and the molded in screen helps prevent pest intrusion. The two-piece design allows for quick and easy installation and is flexible to be installed on homes utilizing various construction methods, including wood-frame and masonry.	The two-piece Air Vent is used for cross-ventilation of garages, foundations, and range hoods. Design allows for open or closed flaps. The molded mesh helps prevent insect intrusion.	The Louvered Exhaust Vent is used to vent dryers and bathroom exhaust fans. The unique design includes a built-in grid to prevent bird intrusion and a 10" long metal tube that can be used for extra thick walls. Design allows for open or closed flaps.	The Intake Louver Vent is designed to be used with the 4" Louvered Exhaust Vent (EXVENT) when constant airflow is required. Primarily used for high-efficiency furnaces, fireplaces, and bathroom eave exhausts.	The Soffit Intake Vent provides necessary air movement through the attic and roof system to replace moist air with fresh air. Can be used with bathroom and kitchen exhausts. FIRE HAZARD: NEVER use Soffit Intake Vent with screen for dryer ventilation. Flammable lint build-up on screen can cause a fire. Always use a vent that is specifically designed for dryer applications.	The Hooded Exhaust Vent features snap-on installation and a concealed flap that stays closed when not in use. NOTE: 6" vent has a screen for use as an intake vent.
Product Code	FVENT	AIRVENT	4" EXVENT 6" EXVENT6	INTAKE	INTVENT	4" DRYERH00D 6" DRYERH00D6
Surface Dimensions	8 3/4" x 17"	7" x 11"	4" 7" x 7" 6" 9" x 9"	4 5/8" H x 4 5/8" W x 1 5/8" D	8" x 8"	4" 6 7/8" x 6 7/8" 6" 8 1/2" x 8 1/2"
Flange Dimensions	9 1/2" x 18 1/4"	7 3/4" x 12 3/4"	4" 8 1/2" x 7 1/2" 6" 9 1/2" x 10 3/8"	—	7 1/2" x 7 1/2"	4" 6 5/8" x 6 5/8" 6" 8 1/4" x 8 1/4"
J-Channel I.D.*	3/4" adjusts to 1 1/4"	3/4" adjusts to 1 1/4"	3/4" adjusts to 1 1/4"	—	5/8" adjusts to 1 1/4"	3/4" adjusts to 1 1/4"
Net Free Area	50 sq in	19 sq in	4" 9.2 sq in 6" 17.6 sq in	5.5 sq in	9.2 sq in	4" 12.6 sq in 6" 28.3 sq in
Limited Lifetime WARRANTY	✓	✓	✓	✓	✓	✓
MULTI DEPTH	✓	✓	✓	✓	✓	✓
PERFECT MATCH	✓	✓	✓	✓	✓	✓
Technical Drawings						

Tube Thickness: 0.0157"

* J-Channel internal dimension



Base
Installed With Siding



Vent Cap
Installed With Siding

Gable Vents

- Gable Vents are available in round, square, octagonal, half-round and rectangular shapes
- Ply Gem's two-piece gable vent system is fully compatible with all siding profiles
- Simply install a base when installing the siding, then snap on the cover later
- Rectangular bases, instead of round, makes siding cuts easier
- No need to install entire gable vent and then cut the siding around it
- Multi Depth feature for premium siding installations that include foam backing
- Ventilates attic
- Available in virtually all vinyl siding colors
- Paintable version available
- Adjustable $5/8"$ – $1\ 1/4"$ for use with all siding styles



	Round Design			Round Top Design		Half-Round Design
Size	18"	22"	36"	14" x 22"	24" x 34"	34" x 22"
Ventilated Opening	10" x 12 1/2"	10 1/2" x 15"	20 1/2" x 26"	10" x 12 1/2"	20 1/2" x 26"	20" x 16"
Outside Unit Dimensions	18"	22"	36"	14" x 22"	24" x 34"	34" x 22"
Net Free Area (sq in)	48.36	48.37	277.1	53.17	191	80.46
Product Code	RDGV18	RDGV	RDGV36	RDTOPGV14	RDTOPGV24	HRDGV

Technical Drawings

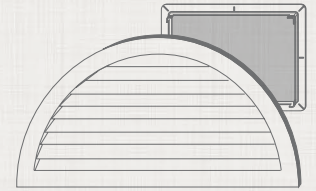
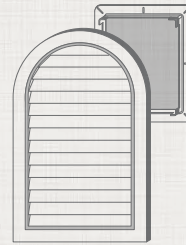
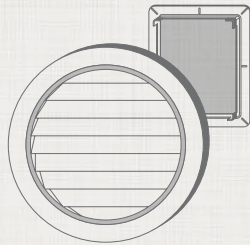

	Rectangular Design			Octagonal Design		Square Design
Size	14" x 20"	18" x 24"	24" x 30"	18"	22"	14" x 14"
Ventilated Opening	10 1/2" x 15"	16" x 20"	20 1/2" x 26"	10" x 12 1/2"	10 1/2" x 15"	10" x 12 1/2"
Outside Unit Dimensions	14" x 20"	18" x 24"	24" x 30"	18"	22"	14" x 14"
Net Free Area (sq in)	23.29	92.88	181.2	49.72	49.5	33.59
Product Code	RECTGV1420	RECTGV1824	RECTGV2430	OCTGV18	OCTGV	SQGV1414

Technical Drawings

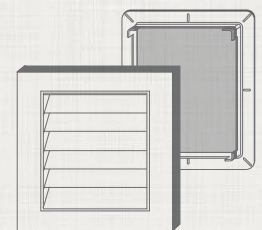
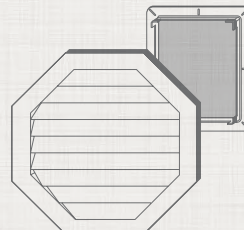
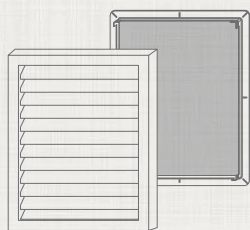

Mantel Systems



Standard Length

- Choose from 36", 40" or 44" base lengths for standard window widths
- Endcaps are available to create narrower Mantel Systems
- Available in a clean, classic design or with Dentil trim
- Add the Keystone for decorative effect
- Ply Gem Mantel Systems are available in White and can be painted for a custom look
- Constructed of low-maintenance, weather-resistant materials

Long Length

- Available in 120" (10') base length for garage door and wide window applications
- Endcaps can be used to finish siding or brick applications
- Create a clean, classic design with the Mantel System with a Plain Cover Strip or add the Dentil Strip for a richer effect
- Add the Keystone to join two Mantel Systems together over a two-car garage door or for decorative effect over a standard opening
- Ply Gem Mantel Systems are available in White and can be painted for a custom look
- Constructed of low-maintenance, weather-resistant materials

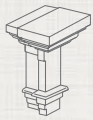

ENDCAP
Endcap

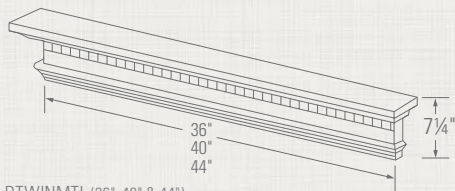

DTWINMTL (36", 40" & 44")
Window Mantel
with Dentil Strip



KEYSTONE
Keystone
Height: 8 3/4"
Length: 7 3/4"

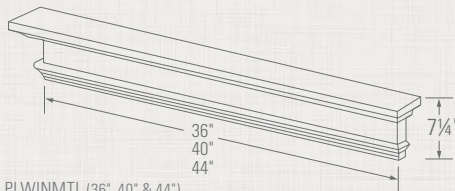

PLWINMTL (36", 40" & 44")
Window Mantel

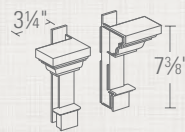

SDGENCAP
Siding Endcaps for
120" Mantel Systems

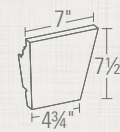

KEYSTN
Keystone for 120"
Mantel systems

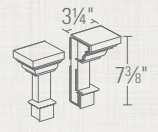

BRKENDCAP
Brick Endcaps for
120" Mantel Systems

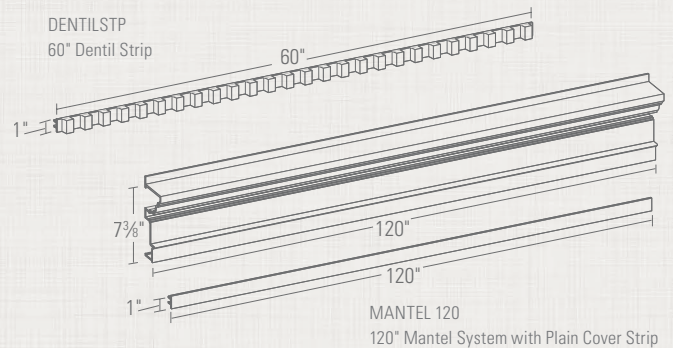

DENTILSTP
60" Dentil Strip

MANTEL 120
120" Mantel System with Plain Cover Strip

ORDER GUIDE

- Measure the width of the window to determine the appropriate item to order (36", 40" or 44")
- Order one Endcap if you need to create a narrower mantel system
- Order one Keystone to create a wider mantel system

ORDER GUIDE

- Measure the width of the door or window and order the appropriate widths as follows:
- Order one Mantel and one set of appropriate (brick/siding) Endcaps for garage door spans 10' wide and narrower
 - Order two Mantels, one set of appropriate (brick/siding) Endcaps and one Keystone for applications over 10'

Door Surrounds



- Pilaster Sets are available in 96" and 144" kits to fit most standard height entrances
- Use the classic Door Surround Mantel for a simple design statement or combine it with the Pediment Set for a stately effect over the top of the doorway
- Add the Door Mantel Overlay to join two Door Surround Systems together for applications over wider doorways
- Constructed of highly durable polystyrene for long-term wearability
- Ply Gem Door Surround Systems are available in White and can be painted for a custom look
- Constructed of low-maintenance, weather-resistant materials

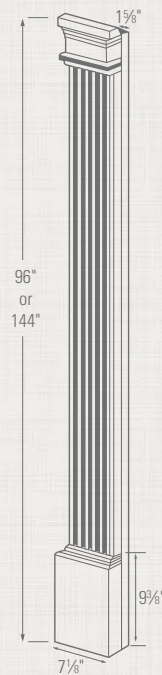
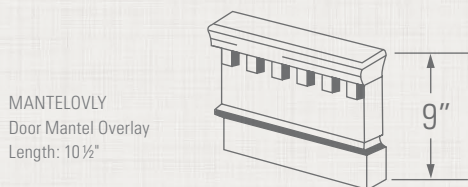
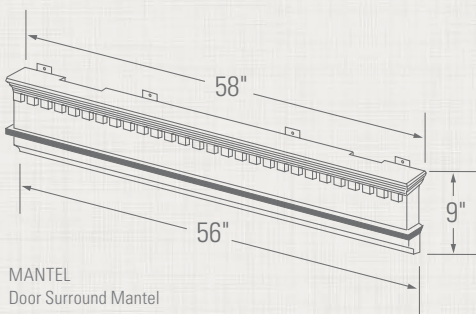
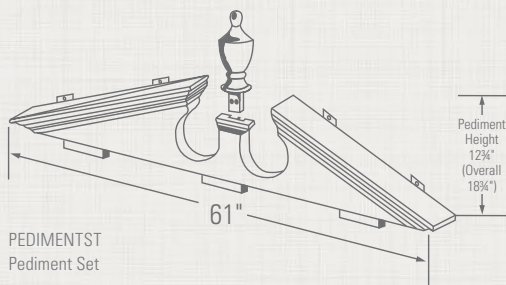

PILASTER 96/144
Pilaster Set
Pilaster Set includes:
2 Pilasters 2 Pilaster Caps
6 Mounting Clips 2 Pilaster Bases

ORDER GUIDE

- Measure the height of the entryway and order the appropriate Pilaster Set
- Measure the width of the doorway and add 15" in order to cover the Pilasters on each side of the door
- Order one Door Surround Mantel to create a classic design
- For a grand design statement in a standard sized doorway, order one Door Surround Mantel and one Pediment Set
- Order two Door Surround Mantels and one Door Mantel Overlay for applications in doorways wider than 3'

The Color of Brilliance



The colors of your home are an important reflection of your personality and taste. They make your family and guests feel welcome. Not only that, the right colors can improve the long-term value of your home.

At Ply Gem, we understand how personal a color choice can be. That's why we teamed with a national color expert to select the colors that are most attractive, desirable, and flexible to use in exterior accents. In fact, most of our accents can be paired with over 100 different siding colors.

Not only that, our engineers went one step further to create colors that will last and last, blocking penetration from sun, wind and rain. Our colors will retain the fresh look of a new paint job, year after year. The result is beautiful fixtures that are virtually maintenance-free.

In addition, if you need a custom color, many of our exterior accents can be painted to match the current color scheme of your home with a high-quality latex paint. It's the ultimate finishing touch to match your style.

Beautiful On Your Home – Sustainable For The Planet



Ply Gem can help you meet your sustainable building goals and earn points in leading green building certification programs. Our products offer features that positively contribute to sustainable building practices, improved energy efficiency or life cycle benefits of homes. It's all part of the Ply Gem Enviro Initiative, a company-wide commitment to minimize our impact on the environment.

SUSTAINABLE RESOURCES:

- When installed and used properly, Ply Gem products never require paint or stain — which reduces VOCs released into the atmosphere.
- Ply Gem facilities reuse and recycle pallets and packaging material, reducing raw material needs and landfill use.
- Ply Gem works with its suppliers to recycle as many materials as possible, including cores, cardboard padding, paint totes, batteries, light bulbs, toner and paper.

ENERGY EFFICIENCY:

- Ply Gem products are lighter, so they require less fuel to transport, which uses fewer resources and generates less pollution.
- All Ply Gem facilities do their part to conserve energy by doing simple things like turning out lights on weekends and during shutdowns.

LIFE CYCLE BENEFITS:

- Ply Gem Shutters and Accents use thicker construction and a baked lacquer finish to ensure that they hold up well season after season.

enviro snap SHOT

LEED FOR HOMES — POSSIBLE POINTS

0 61

LEED NEW CONSTRUCTION — POSSIBLE POINTS

2 26

NAHB STANDARDS — POSSIBLE POINTS

6 - 21 42



Ply Gem is an active member of USGBC and NAHB — two key industry organizations that are working to define sustainable building practices.



Beautiful Exteriors Start with Ply Gem.

For a complete range of exterior products designed to work together, look no further than Ply Gem. As North America's leader in low-maintenance exteriors, no one offers more styles in more colors or provides more tools to help you create the look you want. From major design elements like siding and windows to architectural accents like trim and moulding, count on Ply Gem for superior quality and outstanding beauty.



Vinyl Siding and Accent Panels



Rainware and Gutter Protection



Windows



Ply Gem Stone



Trim and Mouldings



Fence and Railing



Ply Gem reserves the right to alter, modify or delete items from time to time without notice. Due to printing limitations, colors may not be exactly as shown. Contact your sales representative for actual product and color samples.

*Consult the VSI Website at www.vinylsiding.org for current list of certified products and colors.

Ply Gem and the Ply Gem logo are trademarks of Ply Gem Industries, Inc. and/or its subsidiaries.

© 2019 Ply Gem Shutters and Accents 4601089991101/REVB/MS/CG/1218